

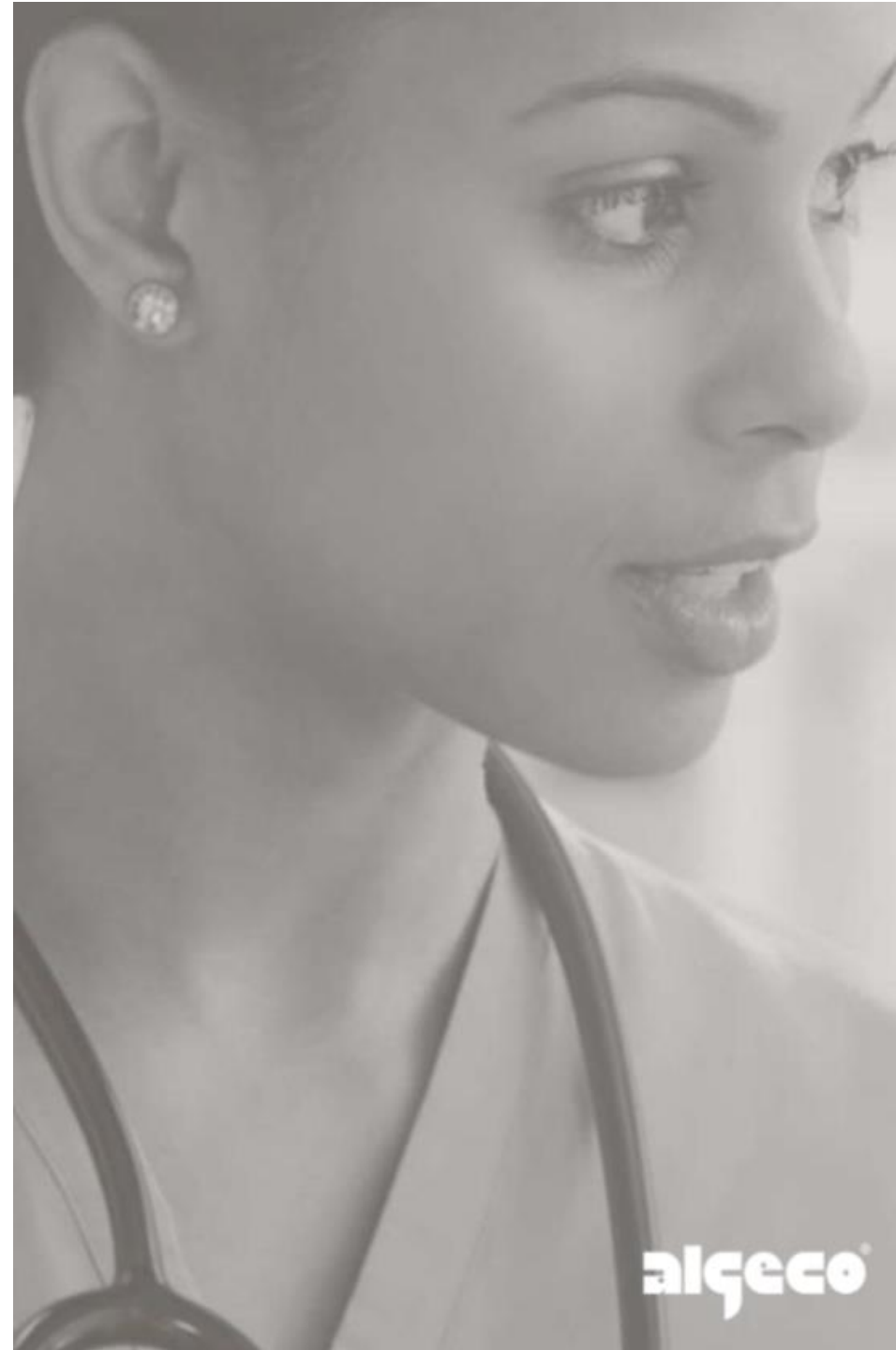

ALGECO SOLUTIONS FOR THE COVID-19 CRISIS

Fast, temporary or permanent,
wherever you need it



algeco[®]

ALGECO SOLUTIONS FOR THE COVID-19 CRISIS



Algeco is Europe and Asia Pacific's leading business services company specializing in modular space. We create **smart spaces** for people to live, work and learn. In front of the emerging Covid-19 virus, we have the possibility to offer solutions to help businesses to deal with this crisis. Our business is designed to **help customers find the right space solution**, no matter what their requirements.



Rapidity



Flexibility



International partners



Fleet availability

- Algeco can help various stakeholders in the management of this COVID-19 crisis in providing the governments, healthcare organizations, civil protection, police, customs, laboratories with fast, flexible, and cost effective solutions.
- With a quarter of a million modules and operations in 22 countries, we provide availability in large quantities and at short notice for customers wherever their need, large or small.
- We are organizing ourselves to be able to provide additional space wherever the COVID-19 crisis requires it to be.



ALGECO HAS GOT ALL RELEVANT EXPERTISE TO SUPPORT STAKEHOLDERS WITH THE COVID-19 CRISIS

QUALITY	<ul style="list-style-type: none">• 50 years of experience in serving in different sectors including the healthcare sector and public administration• Global leader for integrated turnkey solutions• Extensive after sales service
FLEXIBILITY	<ul style="list-style-type: none">• Wide range of units• Experience in providing 360° services• Short planning and preparation phase• Rental or Sales Solutions
QUANTITY	<ul style="list-style-type: none">• 220.000 units in Europe and working across 17 European countries and 22 countries worldwide• Broad network of (inter-) national partners
EFFICIENCY	<ul style="list-style-type: none">• In Europe, production and assembly sites in Czech Republic, France and the UK.• Best-in-class project management guarantees• Responsible use of resources• One contact for transparency and comfort

COVID-19 SOLUTIONS OFFERED

- Hospitals
- Space for triage
- Medical rooms
- Reception/waiting/quarantine/isolation rooms
- Entrance module
- Accommodation and sanitary modules to allow Police and customs to deal with the crisis
- Additional bedrooms or intensive care rooms



With our concept you get a suitable solution covering all needs of all stakeholders during this COVID-19 crisis.

algeco[®]

ALGECO HAS GOT ALL RELEVANT EXPERTISE TO SUPPORT STAKEHOLDERS WITH THE COVID-19 CRISIS

SUPPORTING GOVERNEMENT, INSTITUTIONS AND COMPANIES IN FULFILLING DUTY IN CRISIS SITUATION



Government



Police and Army



Industries



Service Companies



Health care facilities



Administrations



NGOs / Volunteers



Town halls



ALGECO EMERGENCY SOLUTIONS FOR THE COVID-19 CRISIS

Additional space



**Medical care
Mobile hospitals**



Retail facilities



**Waiting Area
Quarantine Rooms**



Catering Room



Outside facilities



Infirmary

Protection for people



Isolated working areas



**Clean changing rooms
/ laundry places**



**Visitors and suppliers
space**



**Entrance Module for
enterprise and industries**



**Turnstiles, Entrance
security**



Triage area

CONFIGURATIONS ADAPTED TO ALL NEEDS RELATED TO COVID-19 CRISIS

HEALTH / PROTECTION / SANITY

Lockers for medical stuff -
before entering into Hospital

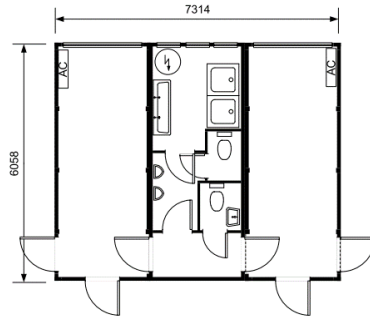

Triage spaces for
medical personal
including WC and
Shower or Sink:

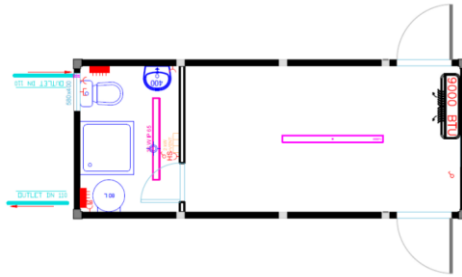

Turnstiles Security Container

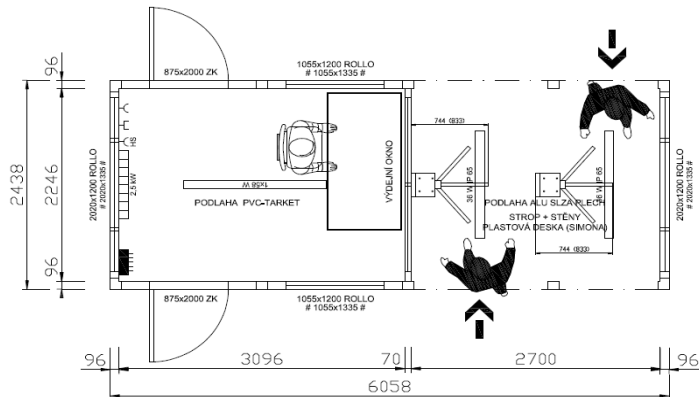

Provide protection area
against Coronavirus
In Public & Private (
Automotive, Logistics,
Biotechnology, Food
Industries, etc)

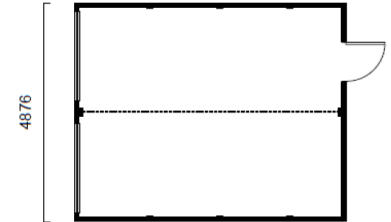

„High flexibility with Standard or
customised configurations.“

„From single products to
sophisticated buildings“

Sub intensive care solution

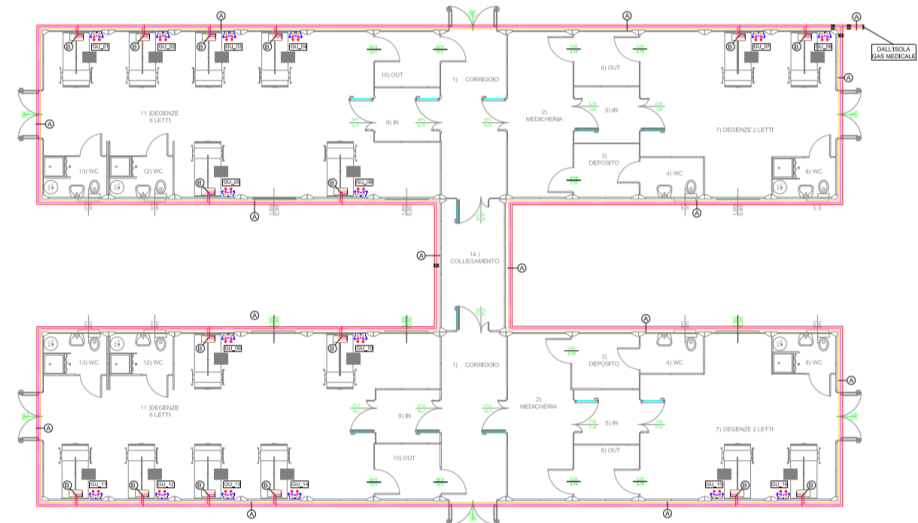

ALGECO EXPERTISE IN EMERGENCY MANAGEMENT

ALGECO's expertise and experience

International crisis experience

- 500 bed Hospital in China delivered in 15 Days
- 60 beds Hospital and accommodations delivered in 45 days for Earthquake in Italy
- First Covid-19 solutions delivered in a few days

Strengths

- Modular
- Turnkey solutions
- Quick delivery
- Cost effective

Expert of crisis Management

- Emergency response procedures
- Communication between stakeholders in emergency situations
- Broad network of (inter-) national **partners**



Standard Solutions delivered for Industries and Service Companies in a few days

- Isolation rooms
- Turnstiles and checkpoints
- Units for temperature measurement



Significant experience with the Public Sector

- Emergency Hospitals
- Administration buildings



Earthquake Solutions provided in Italy

- Emergency Hospital
- Accommodations



Refugee crisis Major projects realized

- Reception centers
- City/district/municipal housing



China Covid-19 Crisis

- Hospital in China delivered in 15 Days
- 24h Work

EXPERIENCE IN EMERGENCY SITUATIONS PROVEN IN PRACTICE

- **Mobile Hospital for 60 people in need of medical care after Earthquake in L'Aquila (Italy).**
- **Facilities include 15 rooms for patients with sanitary, intensive care, sterilization room, operation theatre rooms, Xray, entrance for emergency vehicles**
- **Accessible for people with disabilities**
- **This Hospital is currently used for fighting COVID-19 virus**

Mobile Hospital

Protezione Civile

Turnkey Solution with medical gas plant delivered in 45 days after the Earthquakes in L'Aquila (Italy).



Gross base area ca.: 2500 m²
 Number of Modules: 110
 Rooms for for ca.: 60 People
 Construction time: 45 Days



EXPERIENCE IN EMERGENCY SITUATIONS PROVEN IN PRACTICE

- For 300 people in need of shelter
- Facilities include community kitchen, separate living spaces with inflat kitchen, private bathroom and two rooms
- Accessible for people with disabilities, facilities for social workers, pedagogical experts and physiotherapists, health care facilities

Accommodation for 300 people delivered in 14 weeks during the Refugee crisis in Germany.

Gross base area ca.: 3165 m²
Number of Modules: 252
Living space for ca.: 300
People
Construction time ca.: 14 Weeks

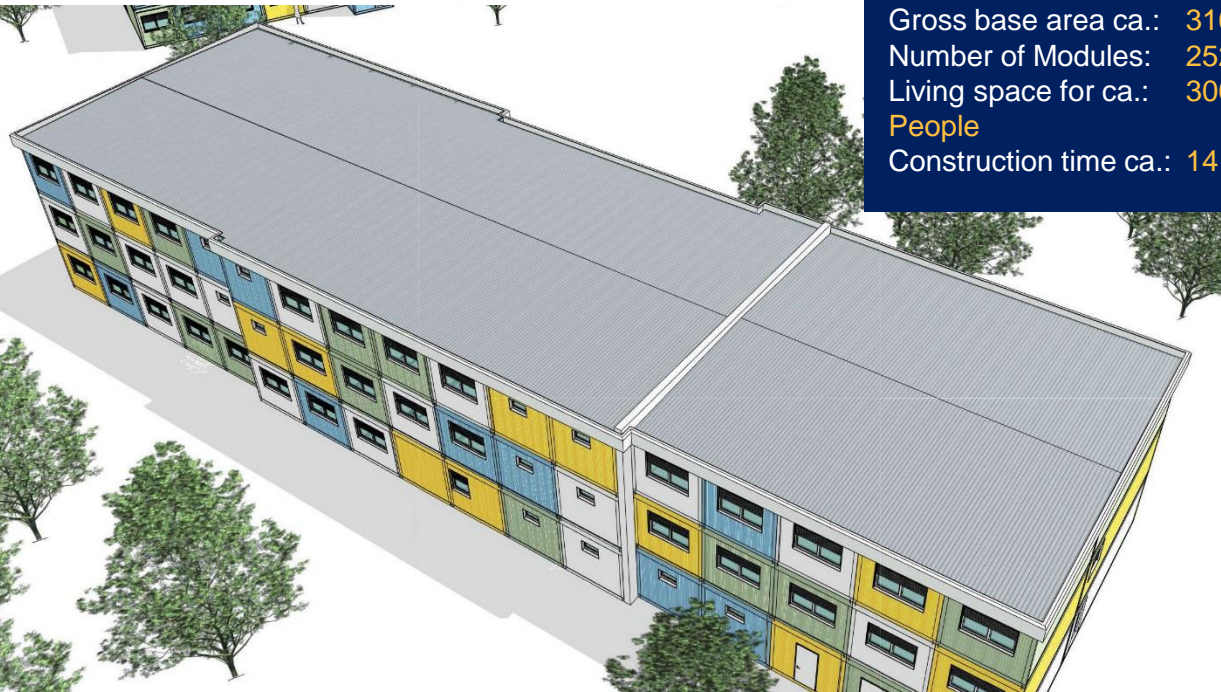
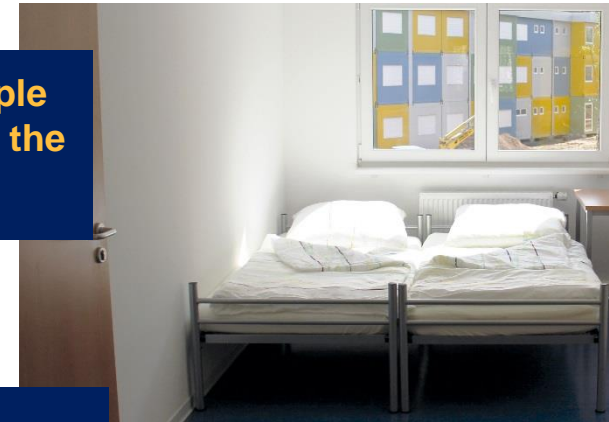

PROJECTS ALREADY DELIVERED FOR COVID-19 VIRUS IN CHINA

HEALTH / PROTECTION / SANITY

“Xi'an Public Health Center” Project in China (Shaanxi Province) built to fight the Coronavirus

February 2020



- 380 units provided by Algeco
- Hospital with ward, sanitary, shower, corridor, stair, etc. to have additional space and beds.
- Construction in 15 days

A project finished in 15 days

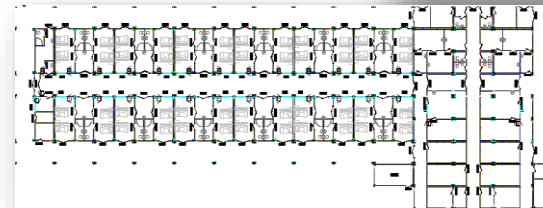
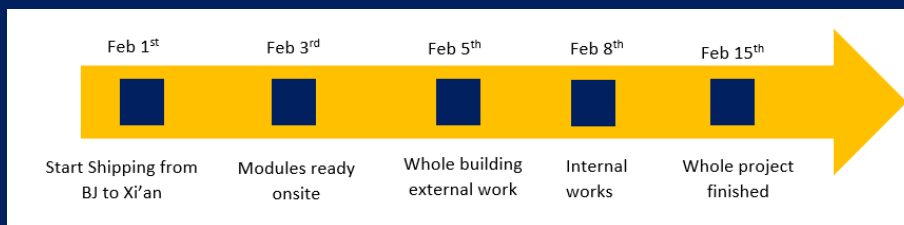

PROJECTS ALREADY DELIVERED FOR COVID-19 VIRUS IN EUROPE

HEALTH / PROTECTION / SANITY

Turnstiles – Czech Republic



Local hospital – Romania



Isolation rooms in public hospitals – CH Lisboa Norte – Portugal – 150m² – 10 units Delivered in 7 days



Many Projects Ongoing

- Turnstiles and checkpoints
- Temporary hospitals & quarantine, emergency accommodation
- day rooms for hospital staff
- MEDIREX SK temporary mobile ambulance (Includes glass door and 30x30 cm window for temperature measurement)
- Units for taking virus samples
- Sanitary units for people waiting for sample taking (sanitary + waste tank + water reservoir)

HOW CAN ALGECO HELP YOU?



CZ +420 733 690 207
SK +421 911 705 276



Info.cz@algeco.com
trnava.sk@algeco.com

For further information:

www.algeco.cz www.algeco.sk



algeco[®]